

# Connettori femmina a carrello

## Female connectors rising clamp

## Connecteurs femelle étrier remontant

## Buchsensteckblock Liftprinzip

### MRT3

**Blocco unico**  
Monobloc

**Single block**  
Einzelblock

**Poll**  
Pôles

**Poles**  
Polzahl

2/24



**5**

**5,08**

320

20

0,2 + 2,5 30 + 12	0,2 + 2,5 30 + 12	0,2 + 2,5 30 + 12	
7			
0,5	/		5
160			
PA - UL 94 V0			
M3			
⊖			
0,6 x 3,5			

V

A

mm²/AWG

320

20

0,2 + 2,5

300

12

30 + 12

min 2 - max 24

VE

80

**Versione**  
Version

...

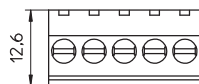
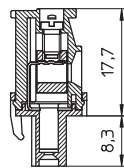
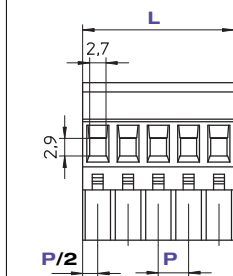

P	L (mm)
5	5 x p
5,08	5,08 x p

### MRT3..V01

**Blocco unico**  
Monobloc

**Single block**  
Einzelblock

**Poll**  
Pôles

**Poles**  
Polzahl

2/24



**5**

**5,08**

320

20

0,2 + 2,5 30 + 12	0,2 + 2,5 30 + 12	0,2 + 2,5 30 + 12	
7			
0,5	/		5
160			
PA - UL 94 V0			
M3			
⊖			
0,6 x 3,5			

V

A

mm²/AWG

320

20

0,2 + 2,5

300

12

30 + 12

min 2 - max 24

VE

80

**Versione**  
Version

**V01**

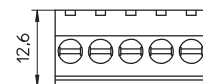
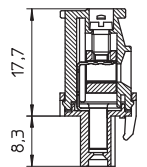
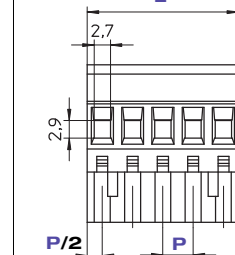

P	L (mm)
5	5 x p
5,08	5,08 x p

<b>Passo</b> Pas	<b>Pitch</b> Rastermaß	mm
<b>Tensione nominale</b> Tension nominale	<b>Rated Voltage</b> Bemessungsspannung	V
<b>Corrente nominale</b> Intensité nominale	<b>Rated Current</b> Bemessungsstrom	A

<b>Tipo cavi</b> Type du conducteur	<b>Types of cables</b> Leitungstypen	
<b>Sezione nominale</b> Section nominale	<b>Nominal cross section</b> Nennquerschnitt	mm² AWG
<b>Lunghezza spelatura</b> Longueur de dénudage	<b>Stripping length</b> Abisolierlänge	mm
<b>Coppia di torsione</b> Couple de serrage	<b>Torque</b> Drehmoment	Nm Lb-in
<b>Temperatura</b> Température	<b>Temperature</b> Temperatur	°C
<b>Corpo isolante</b> Corps isolant	<b>Housing</b> Isolierkörper	
<b>Vite imperdibile</b> Vis imperdable	<b>Captive screw</b> Unverlierbare Schraube	
		mm

	<b>IMQ</b>	EN61984
	<b>VDE</b>	EN61984
	<b>UL</b>	UL1059
	<b>cUL</b>	UL1059 + C22.2 n°158

<b>Poll</b> Pôles	<b>Poles</b> Polzahl	X →
<b>Colore standard</b> Coloris standard	<b>Standard colour</b> Standardfarbe	Y →
<b>Altri dati</b> Autres données	<b>Other information</b> Weitere Informationen	pag. Seite

<b>Ordinazione</b> Référence de commande		<b>How to order</b> Bestellschlüssel			
<b>MRT3 P5 / X ... Y ...</b>					
<b>Tipo</b> Type	<b>Passo</b> Pitch	<b>Poli</b> Poles	<b>Versione</b> Version	<b>Colori</b> Couleurs	<b>Numerazione</b> Marquage
Type	Pas	Pôles	Version	Farben	Bedruckung
Typ	Rastermaß	Polzahl	Version	Farben	Bedruckung

**Altri colori a richiesta.** **Other colours on demand.**  
Autres couleurs sur demande. Andere Farben bei Bedarf.

**VE** **GR** **NE** **AR** **BL** **RO**

# MRT3

**Blocco unico**  
Monobloc

**Single block**  
Einzelblock

**Poll** Pôles **2/12**  
Poles Polzahl

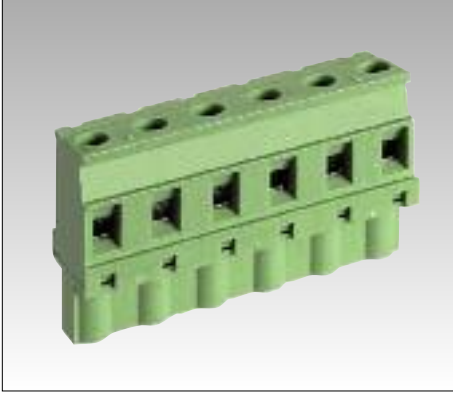

**7,62**

500

20

0,2 + 2,5 30 + 12	0,2 + 2,5 30 + 12	0,2 + 2,5 30 + 12	
7			
0,5	/		5
160			
PA - UL 94 V0			
M3			
0,6 x 3,5			

V	A	mm <sup>2</sup> /AWG
500	20	0,2 + 2,5
300	12	30 + 12

min 2 - max 12

**VE**

81

Versione  
Version

...

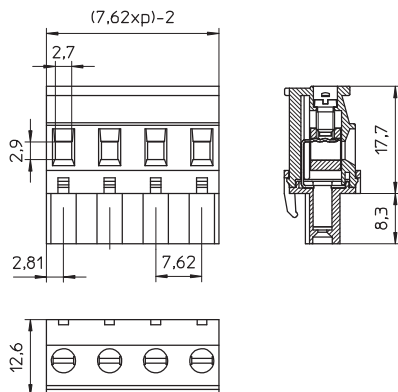

# MRT3..V01

**Blocco unico**  
Monobloc

**Single block**  
Einzelblock

**Poll** Pôles **2/12**  
Poles Polzahl



**7,62**

500

20

0,2 + 2,5 30 + 12	0,2 + 2,5 30 + 12	0,2 + 2,5 30 + 12	
7			
0,5	/		5
160			
PA - UL 94 V0			
M3			
0,6 x 3,5			

V	A	mm <sup>2</sup> /AWG
500	20	0,2 + 2,5
300	12	30 + 12

min 2 - max 12

**VE**

81

Versione  
Version

**V01**

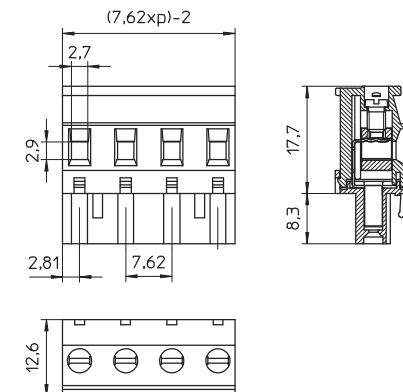

# MRT3

**Blocco unico**  
Monobloc

**Single block**  
Einzelblock

**Poll** Pôles **2/12**  
Poles Polzahl



**10**

**10,16**

630

20

0,2 + 2,5 30 + 12	0,2 + 2,5 30 + 12	0,2 + 2,5 30 + 12	
7			
0,5	/		5
160			
PA - UL 94 V0			
M3			
0,6 x 3,5			

V	A	mm <sup>2</sup> /AWG
630	20	0,2 + 2,5
300	12	30 + 12

min 2 - max 12

**VE**

81

Versione  
Version

...

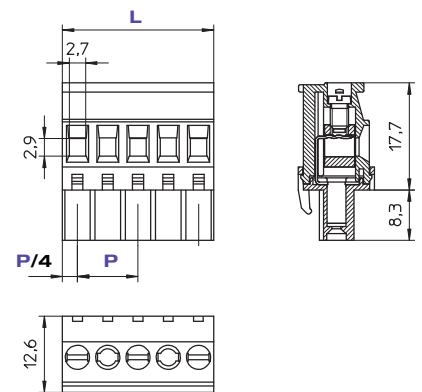

P	L (mm)
10	(10 x p) -5
10,16	(10,16 x p) -5,08

# Connettori femmina a carrello

## Female connectors rising clamp

## Connecteurs femelle étrier remontant

## Buchsensteckblock Liftprinzip

# MRT3..V01

**Blocco unico**      **Single block**  
Monobloc            Einzelblock





**Poli**                      **Poles**                      **2/12**  
Pôles                      Polzahl







<b>Passo</b> Pas	<b>Pitch</b> Rastermaß	mm
<b>Tensione nominale</b> Tension nominale	<b>Rated Voltage</b> Bemessungsspannung	V
<b>Corrente nominale</b> Intensité nominale	<b>Rated Current</b> Bemessungsstrom	A

<b>Tipo cavi</b> Type du conducteur	<b>Types of cables</b> Leitungstypen	
<b>Sezione nominale</b> Section nominale	<b>Nominal cross section</b> Nennquerschnitt	mm <sup>2</sup> AWG
<b>Lunghezza spelatura</b> Longueur de dénudage	<b>Stripping length</b> Abisolierlänge	mm
<b>Coppia di torsione</b> Couple de serrage	<b>Torque</b> Drehmoment	Nm Lb-in
<b>Temperatura</b> Température	<b>Temperature</b> Temperatur	°C
<b>Corpo isolante</b> Corps isolant	<b>Housing</b> Isolierkörper	
<b>Vite imperdibile</b> Vis imperdable	<b>Captive screw</b> Unverlierbare Schraube	
		mm

<b>10</b>	<b>10,16</b>
<b>630</b>	
<b>20</b>	

		
0,2 + 2,5 30 + 12	0,2 + 2,5 30 + 12	0,2 + 2,5 30 + 12
<b>7</b>		
<b>0,5</b>	/	
	<b>5</b>	
<b>160</b>		
<b>PA - UL 94 V0</b>		
<b>M3</b>		
 <b>0,6 x 3,5</b>		

	<b>IMQ</b>	EN61984
	<b>VDE</b>	EN61984
	<b>UL</b>	UL1059
	<b>cUL</b>	UL1059 + C22.2 n°158

V	A	mm <sup>2</sup> /AWG
<b>630</b>	<b>20</b>	0,2 + 2,5
<b>300</b>	<b>12</b>	30 + 12

<b>Poli</b> Pôles	<b>Poles</b> Polzahl	<b>X →</b>
<b>Colore standard</b> Coloris standard	<b>Standard colour</b> Standardfarbe	<b>Y →</b>
<b>Altri dati</b> Autres données	<b>Other information</b> Weitere Informationen	<b>pag.</b> Seite

<b>min 2 - max 12</b>
<b>VE</b>
<b>81</b>

<b>Ordinazione</b> Référence de commande		<b>How to order</b> Bestellschlüssel			
<b>MRT3 P10 / X V01 Y ...</b>					
<b>Tipo</b> Type	<b>Passo</b> Pitch	<b>Poli</b> Poles	<b>Versione</b> Version	<b>Colori</b> Couleurs	<b>Numerazione</b> Marquage
Type	Pas	Pôles	Version	Farben	Bedruckung
Typ	Rastermaß	Polzahl	Version	Farben	Bedruckung

**Altri colori a richiesta.**      **Other colours on demand.**  
Autres couleurs sur demande.      Andere Farben bei Bedarf.



**Versione**  
Version  
**V01**

<b>P</b>	<b>L (mm)</b>
<b>10</b>	<b>(10 x p) -5</b>
<b>10,16</b>	<b>(10,16 x p) -5,08</b>